



ASCLASS

ASCLASS CERRAHİ ALETLER İMALAT SAN. VE TİC. LTD.ŞTİ

📍 Çatalarmut Mahallesi Sezgin Sokak No:7 Kat:1/2/3 İlkadım/SAMSUN

📱 asclasscerrahialetler.ve.medya 🌐 Asclass cerrahi aletler 🌐 www.asclassgrup.com 📧 info@asclassgrup.com - asclassmedya@gmail.com

ÜRÜN GRUPLARIMIZ

- » Genel Cerrahi
- » Beyin Cerrahi
- » Ortopedi Cerrahi
- » Göz Cerrahi
- » Kulak Burun Boğaz
- » Jinekoloji
- » Üroloji
- » Kalp Damar
- » Üniversal Ekartör Setleri
- » Laparoskopik Ekartör Setleri
- » Laparoskopik El Aletleri
- » Steril Konteynir Sistem

46-

DIAMOTE ağızlar, daha sert ve aşınmaya dayanıklı yüzeyler sağlar.
DIAMOTE ağızlar, hassas iğne, suture ve dokuların güvenilir bir şekilde kavranmasını garanti eder.

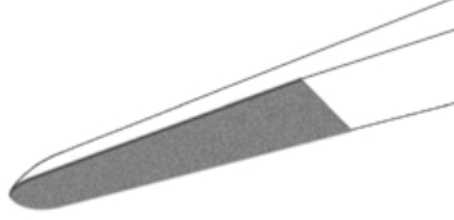

DIAMOTE jaws provide harder and more wear resistant surfaces.
DIAMOTE jaws ensure reliable grip of fine needles, sutures and tissues.



Suture 5-0 ve daha küçükler için
 For sutures 5-0 and smaller

1/2

46-100
 Kilitli/Without lock
 21 cm



46-101 / 46-102

1/2

46-101 - 46-102
 Kilitli/With lock
 18 cm



Suture 5-0 ve daha küçükler için
 For sutures 5-0 and smaller

1/2

46-103
 Kilitli/With lock
 21 cm



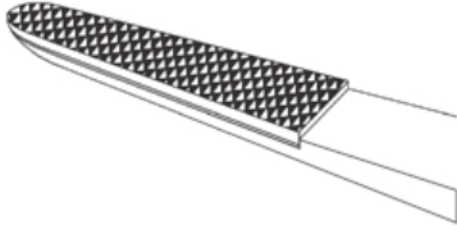

Elmas Uclu Portegüler :

Asclass Portegülerinin ağızlarındaki elmas uclarının kullanıma göre yüzey yapısı seçilebilir.

Asclass elmas uclu portegülerinin 4 farklı yüzeyi vardır. Pürüzsüz yüzey ve 3 farklı çentik yüzeyi uygun iğne yakalamayı sağlar.

Needle holders with carbide inserts.

The carbide inserts on ASCLASS needle holders can be selected base on usage.

ASCLASS needle holders with carbide inserts have four different surface types. Smooth surface and there different notched surfaces provide appropriate needle catch.



Düz
smooth

Pürüzsüz yüzeye sahip ağızlarda kullanılacak, dikiş malzemesi için: 9/0 - 11/0

With smooth jaw surface for suture materials: 9/0 - 11/0



0,20

0.2 mm adımlı çentiğe sahip ağızda kullanılacak, dikiş malzemesi için: 6/0 - 10/0

With 0.2 mm pitch of serration for suture material: 6 /0 - 10/0



,4

0.4 mm adımlı çentiğe sahip ağızda kullanılacak, dikiş malzemesi için: 4/0 - 6/0

0.4 mm pitch of serration for suture material: 4 /0 - 6/0



0,5

0.5 mm adımlı çentiğe sahip ağızda kullanılacak, dikiş malzemesi için: 3/0' a kadar

0.5 mm pitch of serration for suture material: up to 3/0



 V_1
Düz ağız
With smooth jaw

V_2
CASTROVIEJO
46-104
Kilitli/With lock
14.5 cm



 V_1
0,2

V_2
CASTROVIEJO
46-105
Kilitli/With lock
14.5 cm



 V_1
0,4

V_2
46-106
Kilitli/With lock
17 cm



 V_1
0,2

V_2
CASTROVIEJO
46-107 / 46-108
Kilitli/With lock



 V_1
0,2

46-108
21.5 cm



 V_1
0,2

V_2
46-109
Kilitli/With lock
18 cm



 V_1
0,2

V_2
46-110
Kilitli/With lock
20 cm

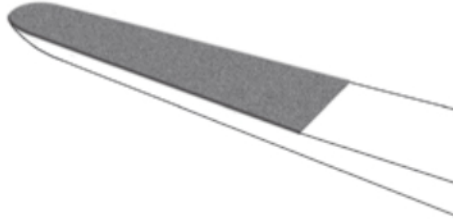

DIAMOTE ağızlar, daha sert ve aşınmaya dayanıklı yüzeyler sağlar.
DIAMOTE ağızlar, hassas iğne, suture ve dokuların güvenilir bir şekilde kavranmasını garanti eder.

DIAMOTE jaws provide harder and more wear resistant surfaces.
DIAMOTE jaws ensure reliable grip of fine needles, sutures and tissues.

Suture 5-0 ve daha küçükler için
For sutures 5-0 and smaller

Suture 7-0 ve daha küçükler için
For sutures 7-0 and smaller

Suture 5-0 ve daha küçükler için
For sutures 5-0 and smaller

Suture 7-0 ve daha küçükler için
For sutures 7-0 and smaller

Suture 4-0 ve daha küçükler için
For sutures 4-0 and smaller

Suture 4-0 ve daha küçükler için
For sutures 4-0 and smaller

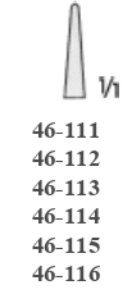

46-111 - 46-122
Kilitsiz/Without lock

46-111	12 cm	46-117
46-112	14.5 cm	46-118
46-113	16 cm	46-119
46-114	18.5 cm	46-120
46-115	21 cm	46-121
46-116	23 cm	46-122



46-123 - 46-146
Kilitli/With lock

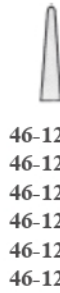

46-123	12 cm	46-129
46-124	14.5 cm	46-130
46-125	16 cm	46-131
46-126	18.5 cm	46-132
46-127	21 cm	46-133
46-128	23 cm	46-134



46-129	12 cm	46-135
46-130	14.5 cm	46-136
46-131	16 cm	46-137
46-132	18.5 cm	46-138
46-133	21 cm	46-139
46-134	23 cm	46-140



46-135	12 cm	46-141
46-136	14.5 cm	46-142
46-137	16 cm	46-143
46-138	18.5 cm	46-144
46-139	21 cm	46-145
46-140	23 cm	46-146

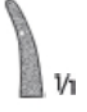

46-141	12 cm	46-147
46-142	14.5 cm	46-148
46-143	16 cm	46-149
46-144	18.5 cm	46-150
46-145	21 cm	46-151
46-146	23 cm	46-152



Suture 2-0 ve daha küçükler için
For sutures 2-0 and smaller



19 cm	46-147
23 cm	46-148
25 cm	46-149

46-147 - 46-149
Kilitli/With lock





Suture 2-0 ve daha küçükler için
For sutures 2-0 and smaller





19 cm	46-150
23 cm	46-151
25 cm	46-152



46-150 - 46-152
Kilitsiz/Without lock



Düz Sap/Flat Handle

	Sütür 7-0 ve daha küçükler için For sutures 7-0 and smaller		Sütür 5-0 ve daha küçükler için For sutures 5-0 and smaller	
				
	14.5 cm	46-153	46-158	
	17 cm	46-154	46-159	
	18.5 cm	46-155	46-160	
	21 cm	46-156	46-161	
23 cm	46-157	46-162		
46-153 - 46-162 Kilitsiz/Without lock				

	Sütür 7-0 ve daha küçükler için For sutures 7-0 and smaller		Sütür 5-0 ve daha küçükler için For sutures 5-0 and smaller	
				
	14.5 mm	46-163	46-168	
	17 cm	46-164	46-169	
	18.5 cm	46-165	46-170	
	21 cm	46-166	46-171	
23 cm	46-167	46-172		
46-163 - 46-172 Kilitli/With lock				

Kanallı Düz Sap/Flat Knurled Handle

	Sütür 5-0 ve daha küçükler için For sutures 5-0 and smaller	
		
	18.5 cm	46-173
	21 cm	46-174
	23 cm	46-175
46-173 - 46-175 Kilitsiz/Without lock		

	Sütür 5-0 ve daha küçükler için For sutures 5-0 and smaller	
		
	18.5 cm	46-176
	21 cm	46-177
	23 cm	46-178
46-176 - 46-178 Kilitli/With lock		



Yuvarlak Saplar

Parmaklar arasında istenildiği şekilde döndürmeye izin verir.

Sağlam veya oyulmuş saplardan dolayı her bir alette optimum denge sağlar

Round Handle

Allows rotation between the fingers as required

Due to carved and strong handle, each instrument provides optimum balance

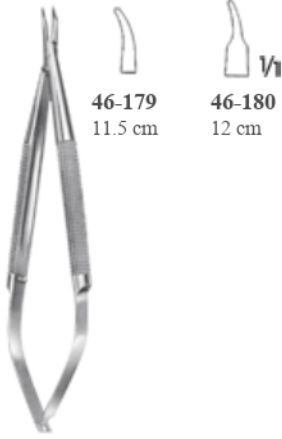

BARRAQUER
Kilitsiz/Without lock



BARRAQUER
Kilitsiz/Without lock
12 cm

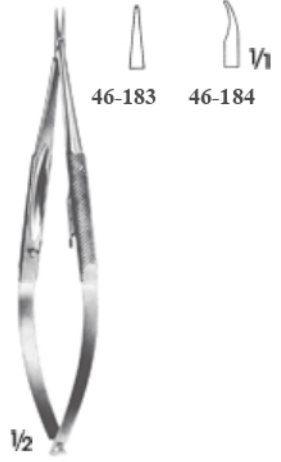

BARRAQUER
Kilitli/With lock
12 cm



Kilitli/With lock
15 cm



REILL
Kilitsiz/Without lock
15 cm



Kilitsiz/Without lock
18.5 cm



Kilitli/ With catch
18.5 cm

Düz Saplar/Flat Handles

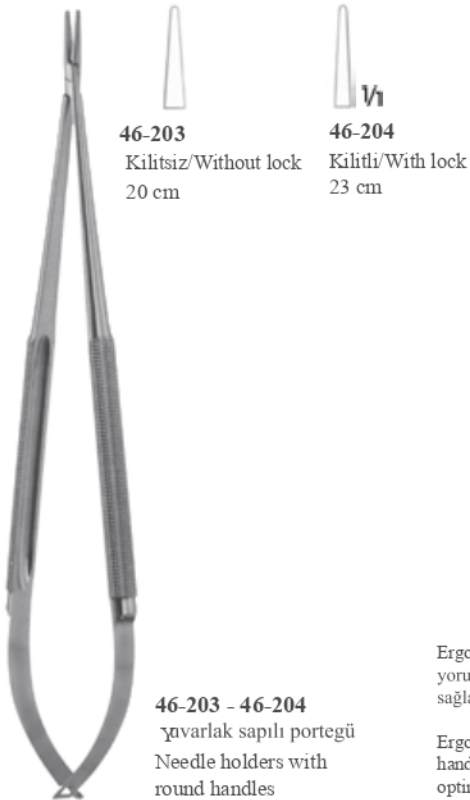
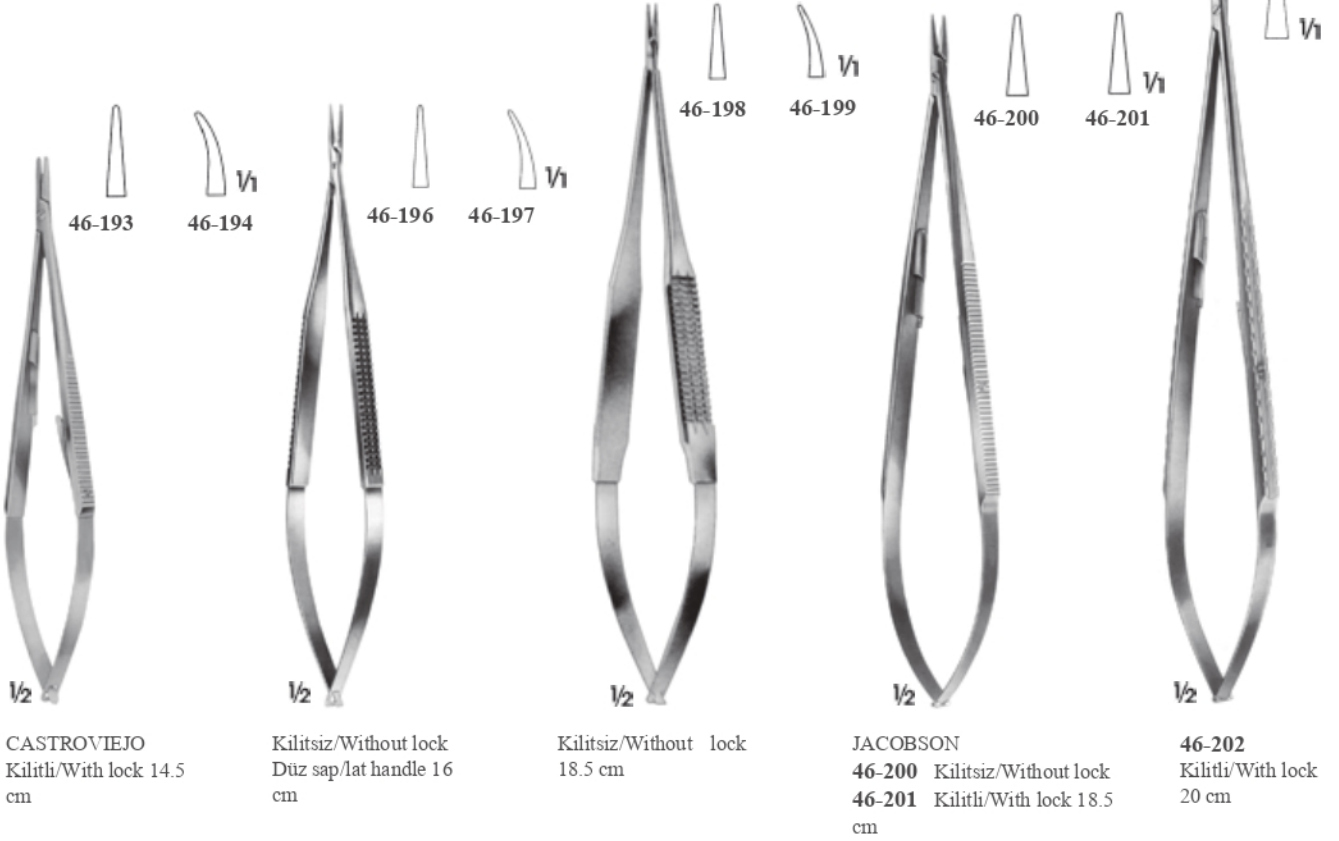

Ergonomik, hafif plastik sap
yorulmadan optimum kullanım
sağlar.

Ergonomic, light weight plastic
handle provides fatigue free,
optimal usage.



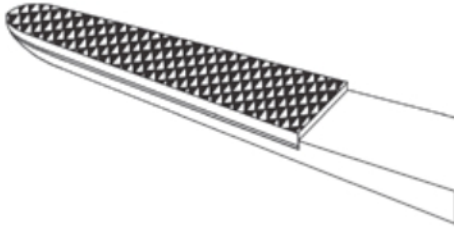

Elmas Uclu Portegüler :

Asclass Portegülerinin ağızlarındaki elmas uclarının kullanıma göre yüzey yapısı seçilebilir.

Bahadır elmas uclu portegülerinin 4 farklı yüzeyi vardır. Pürüzsüz yüzey ve 3 farklı çentik yüzeyi uygun iğne yakalamayı sağlar.

Needle holders with carbide inserts.

The carbide inserts on ASCLASS needle holders can be selected based on usage.

ASCLASS needle holders with carbide inserts have four different surface types. Smooth surface and three different notched surfaces provide appropriate needle catch.



Düz
smooth

Pürüzsüz yüzeye sahip ağızlarda kullanılacak, dikiş malzemesi için: 9/0 - 11/0

With smooth jaw surface for suture materials: 9/0 - 11/0



0,20

0.2 mm adımlı çentiğe sahip ağızda kullanılacak, dikiş malzemesi için: 6/0 - 10/0

With 0.2 mm pitch of serration for suture material: 6/0 - 10/0



,4

0.4 mm adımlı çentiğe sahip ağızda kullanılacak, dikiş malzemesi için: 4/0 - 6/0

0.4 mm pitch of serration for suture material: 4/0 - 6/0



0,5

0.5 mm adımlı çentiğe sahip ağızda kullanılacak, dikiş malzemesi için: 3/0' a kadar

0.5 mm pitch of serration for suture material: up to 3/0



HALSEY
46-205
12 cm



WEBSTER
46-206
12.5 cm



MASING
46-207
Tek ayağı açılı, yüzüklü
One ring angled
13 cm

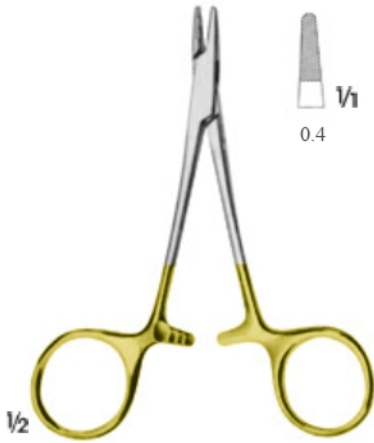
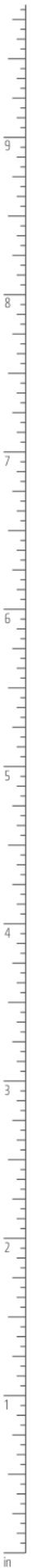

DERF
46-208
11.5 cm

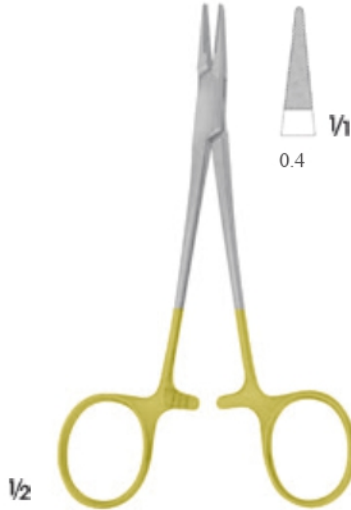

HALSEY
46-209
13 cm

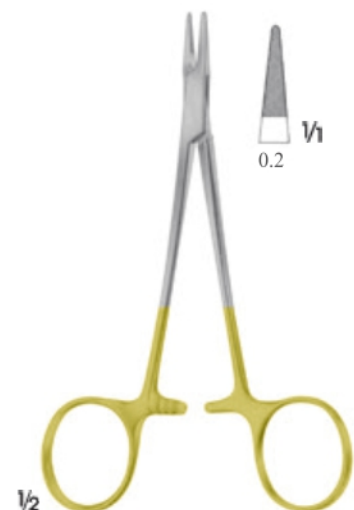

CONVERSE
46-210
13 cm



KILNER
46-211
13.5 cm

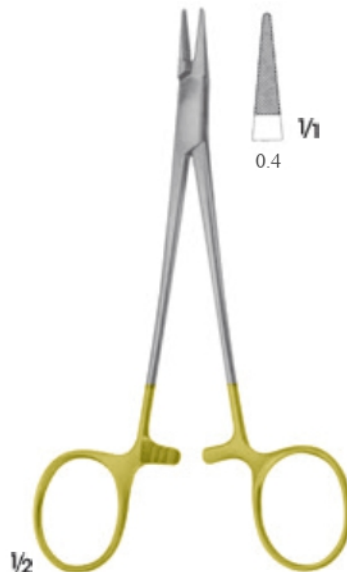







BABY-CRILE-WOOD
46-212
15 cm



BAUMGARTNER
46-213
14.5 cm





HEGAR-MAYO
 46-214 - 46-219

					
0.50	.5	0.50	0.50	.5	.5
46-214	46-215	46-216	46-217	46-218	46-219
15 cm	18.5 cm	20.5 cm	23.5 cm	26.5 cm	30 cm







HEGAR

	
0,50	,5
46-220	46-221
20.5 cm	24.5 cm





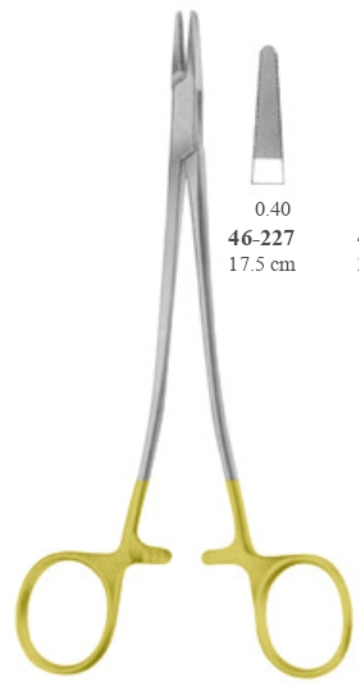

CRILE-WOOD

				
0.4	0.4	0.4	0.4	0.4
46-222 14.5 cm	46-223 18.5 cm	46-224 20 cm	46-225 27 cm	46-226 30.5 cm





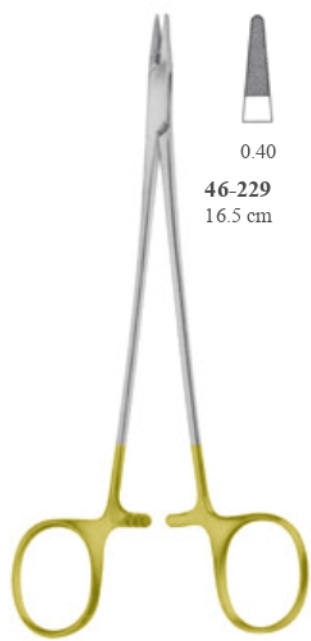

SAROT

	
0.40	.4
46-227 17.5 cm	46-228 26 cm



DE BAKEY
 Çok hassas/Very
 delicate



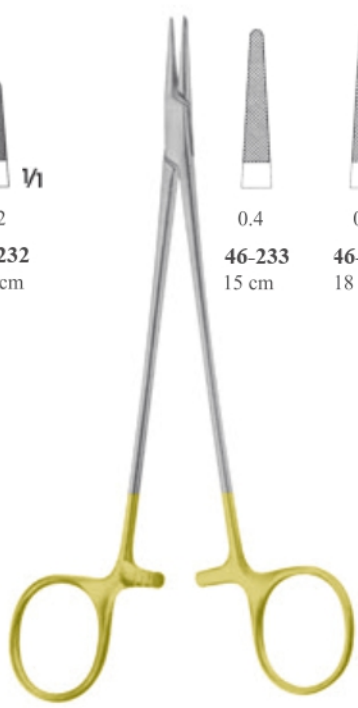

FineCut

			
0.40	0.4	0.2	.2
46-229 16.5 cm	46-230 21 cm	46-231 16.5 cm	46-232 21 cm



DE BAKEY

FineCut

				
0.4	0.4	0.40	.4	0.4
46-233 15 cm	46-234 18 cm	46-235 23 cm	46-236 25 cm	46-237 30.5 cm

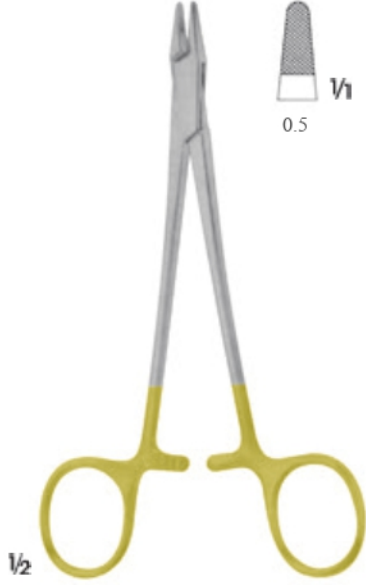

46-238
Tel bükücü /Wire twister
15 cm



46-239
Tel bükücü /Wire twister
15 cm

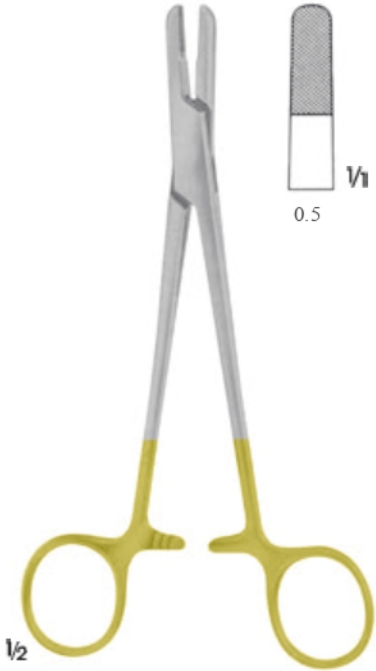

46-240
Tel Bükücü/ Wire twister
Sternum suture için ligatür pensi
Sternum suture for ligature forceps
17.5 cm



BERRY
46-241
Tel bükücü /Wire twister
Ligatür pensi/Ligature forceps
18.5 cm



BAUMGARTNER
46-242
Tel bükücü /Wire twister
Ligatür pensi/Ligature forceps
20 cm



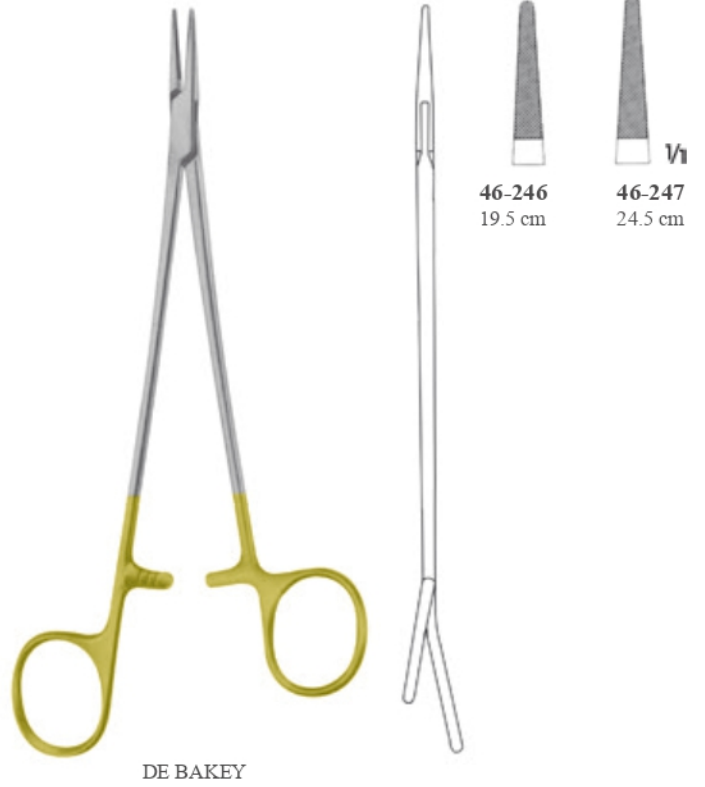
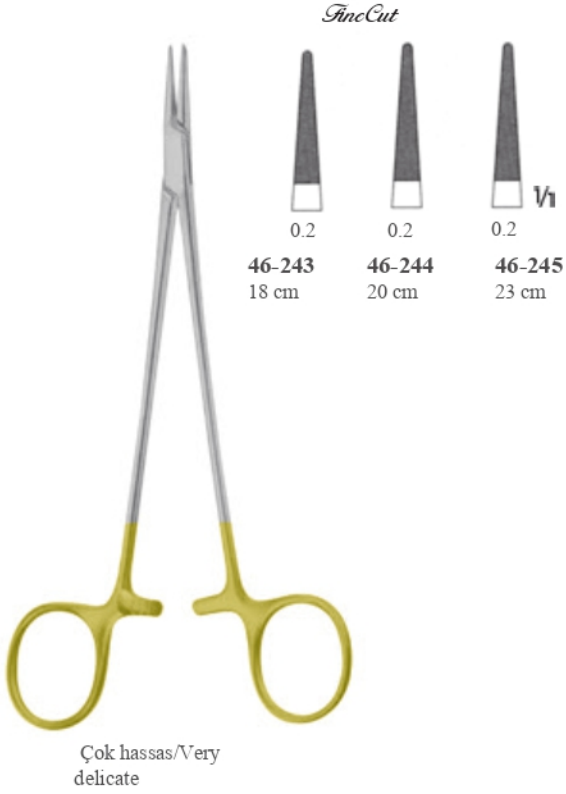

Uzatılmış bir sap ve kavisli yüzükler, optimum tutuş sağlar.
One extended handle and curved rings ensure optimum grip





WERTHEIM



0.50
46-250
20 cm



.5
46-251
24 cm



0.5
46-252
30 cm



HEANEY



0.5
46-253
20 cm



0.5
46-254
26 cm

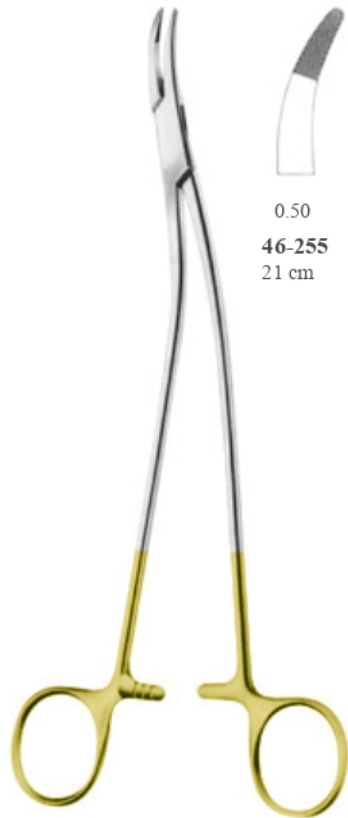

STRATTE



0.50
46-255
21 cm



.5
46-256
23 cm

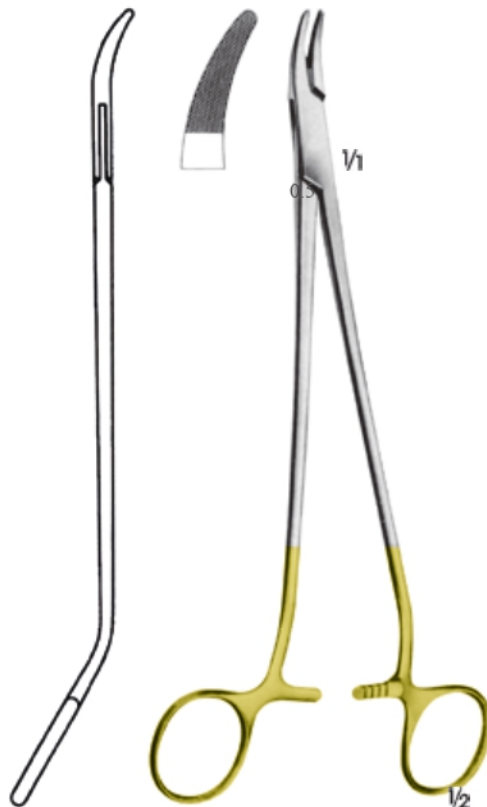

46-257
S şekli portegü/S-shaped needle
21.5 cm



$\frac{1}{2}$



$\frac{1}{2}$
FINOCHIETTO
46-258
26.5 cm



$\frac{1}{2}$
NAUNTON-MORGAN
46-259
26 cm



$\frac{1}{2}$
MÜLLER
46-260
Derin rektum cerrahisi için
For deep rectum surgery
36 cm

- Cerraha maksimum ergonomik rahatlık sağlar.
- Optimize tasarımları sayesinde zor suture ve anastomoz tekniklerinde yorulmadan çalışmayı sağlar.
- Provides maximum ergonomic comfort to surgeon.
- Due to optimized design, it provides fatigue free working on suture and anastomosis techniques.



REIN-KUPKA
46-261
 Kilitli/Without ratchet lock
 19 cm



REIN-KUPKA
46-262
 Kilitli/With ratchet lock
 19 cm



HELLBERG-KUPKA
46-263
 Kilitli/With ratchet lock
 21 cm



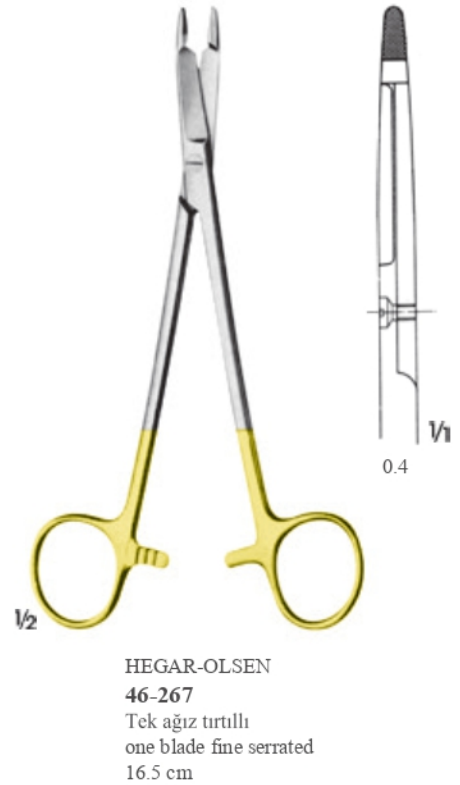

- Hassas çeneler travmatik olmayan ve hassas damar iğnelerini tutmak için uygundur.

- Fine jaws are suitable for gripping non-traumatic needles and vein needles.

FineCut



RYDER
Çok hassas/Very delicate



0.2

46-268
13.5 cm



0.2

46-269
15.5 cm



0.2

46-270
17.5 cm



0.2

46-271
21 cm



0.2

46-272
23 cm



RYDER



0.4

46-273
13.5 cm



0.4

46-274
17.5 cm



0.4

46-275
19.5 cm



0.4

46-276
26.5 cm

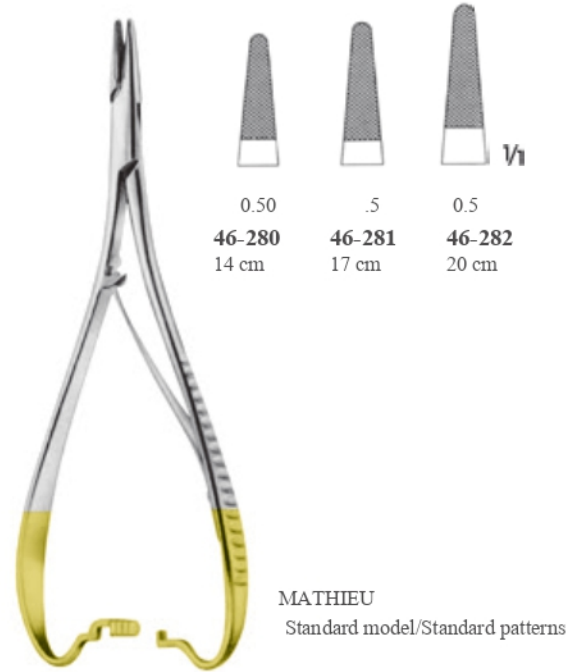
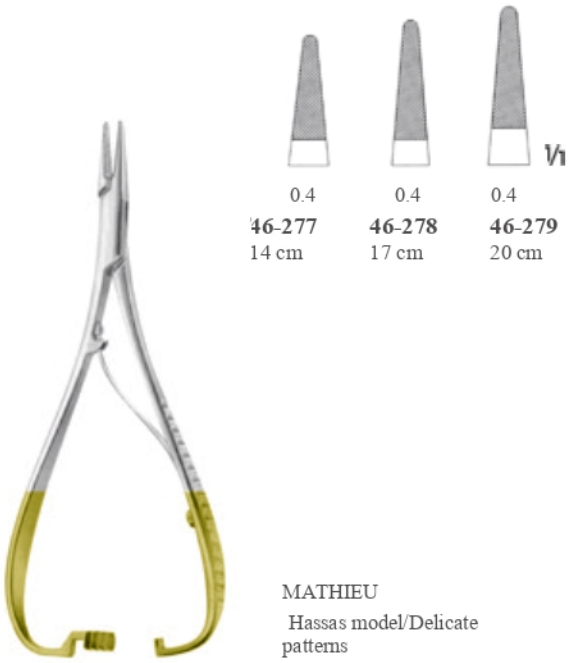

FineCut



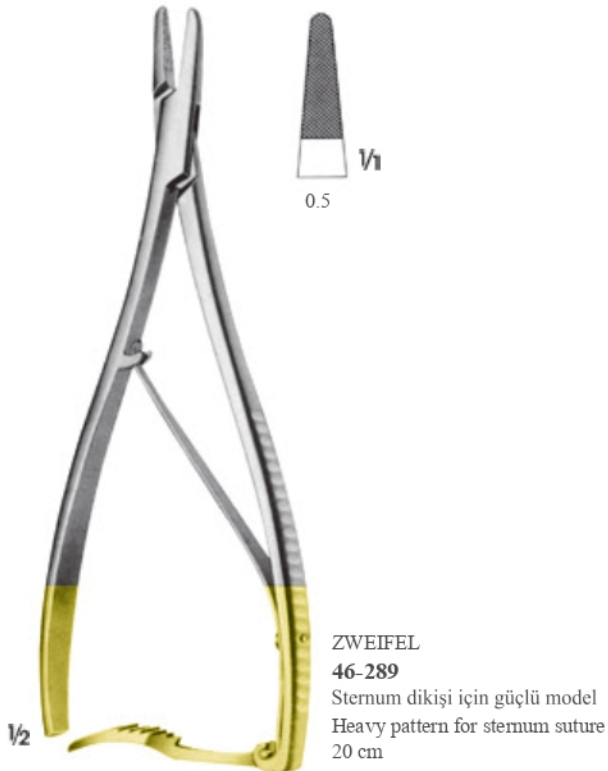



TÖNNIS
46-291
 Elastik model/Elastic pattern
 18 cm



TÖNNIS
46-292
 Elastik model/Elastic pattern
 18 cm



LANGENBECK
46-293
 Elastik model/Elastic pattern
 20 cm

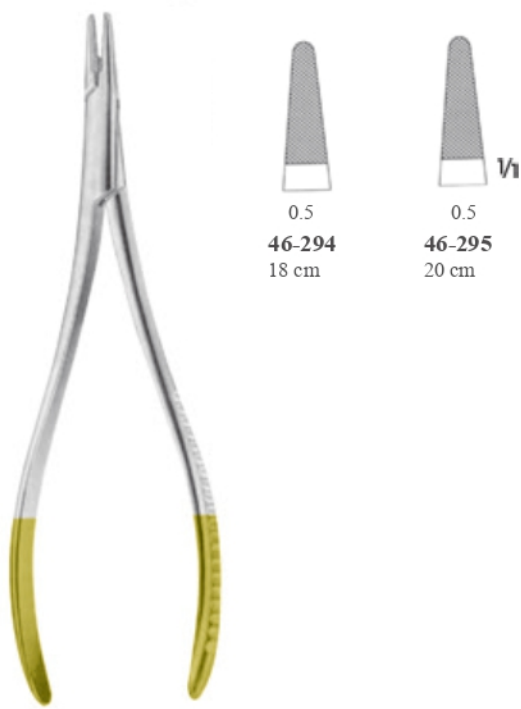

LANGENBECK



46-296



RYDER

Düz ağız/With smooth jaws



J
15 cm



46-297
18 cm



46-298
23 cm

V₁



0.4



1/2

46-299
18 cm



0.4



1/2

46-300
20 cm





MASSON
46-301
26.5 cm



WANGENSTEEN
46-302
27.5 cm



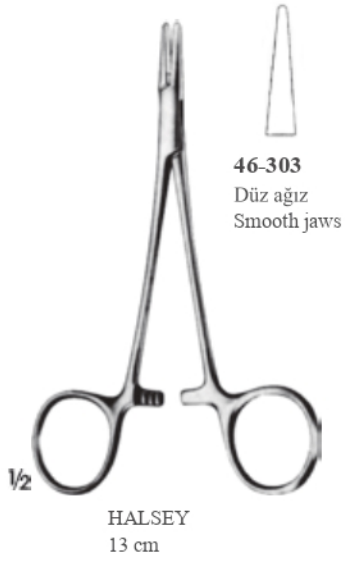

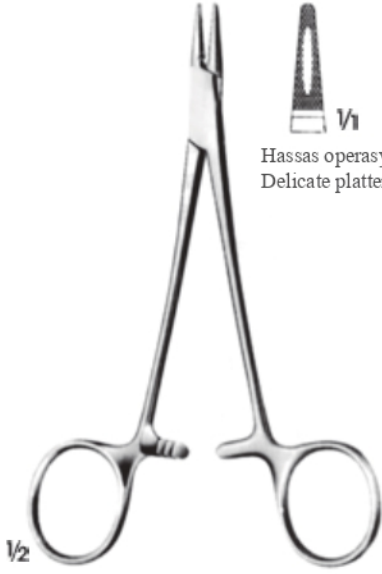

Hassas operasyon için
Delicate plattern

CRILE-WOOD
46-310
15 cm



Zorlu operasyon için
Heavy plattern

CRILE-WOOD
46-311
16 cm

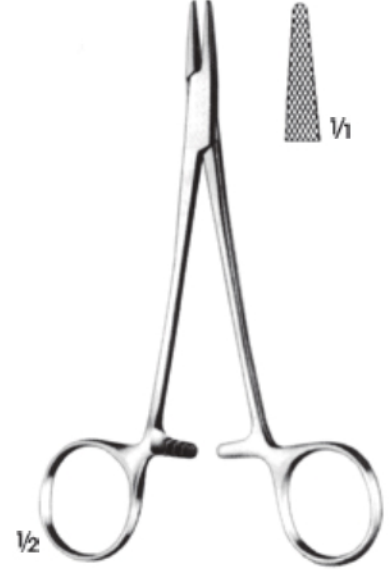

CRILE-MURRAY
46-312
15 cm



46-313
16.5 cm



46-314
19 cm

MAYO-HEGAR



KILNER
46-315
13.5 cm

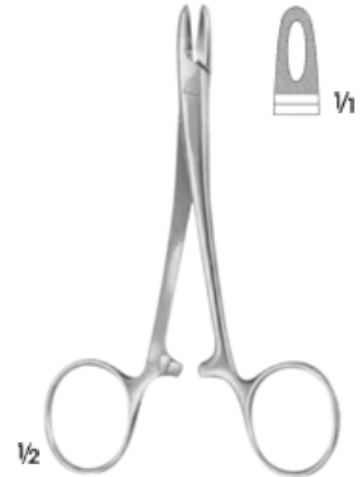

DOYEN
46-316
12.5 cm



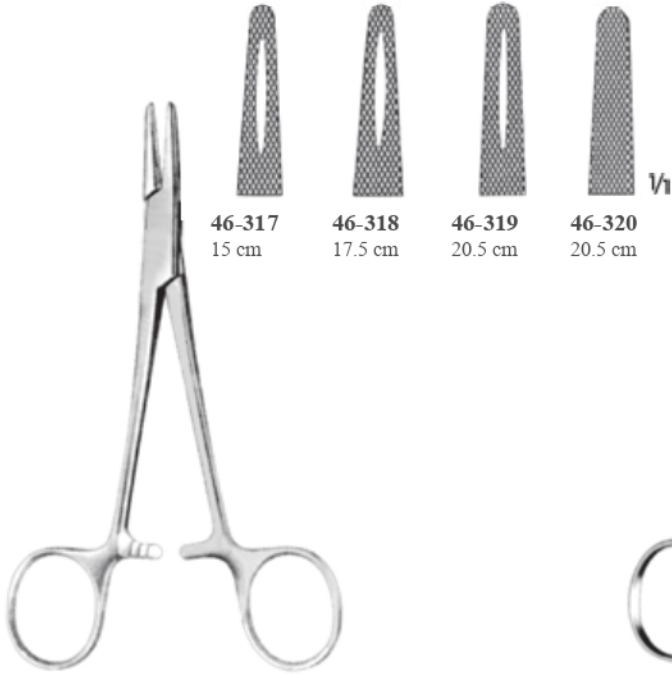

HEGAR
T16-212 - T16-215
Zorlu operasyon için
Heavy patterns

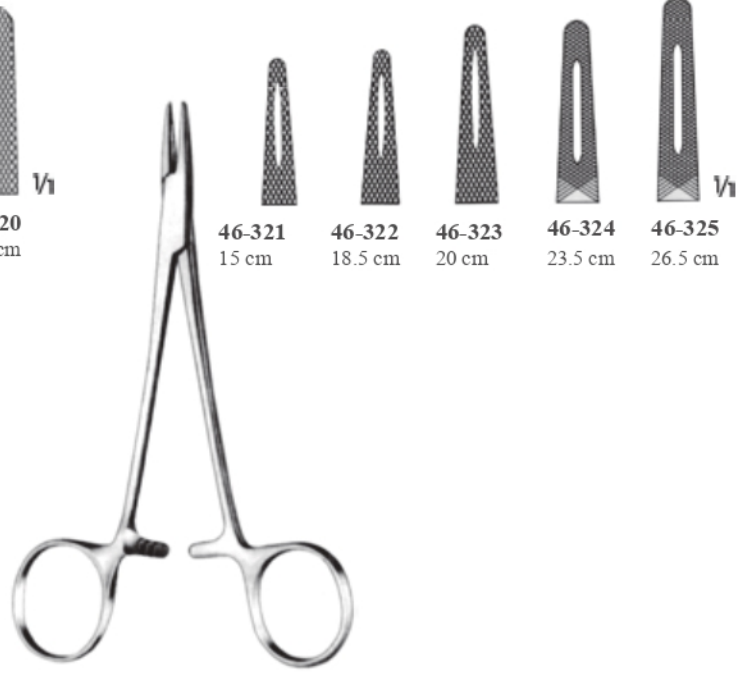

MAYO-HEGAR
T16-216 - T16-220
Orta incelikte dikiş pensi
Medium fine patterns

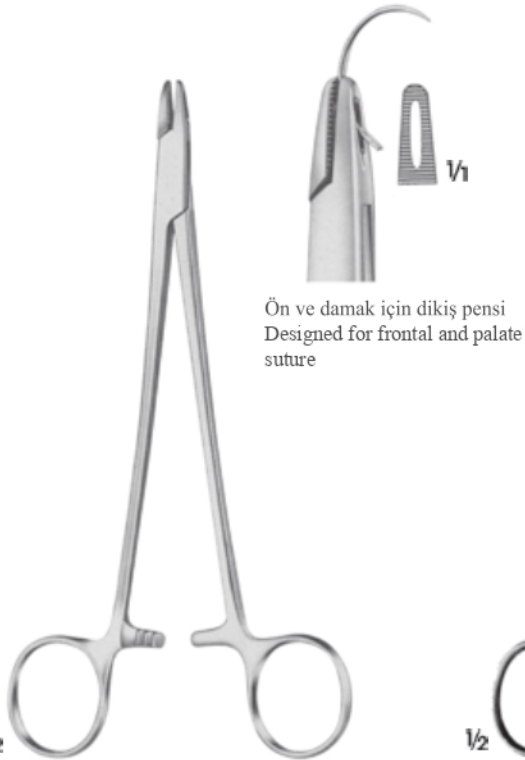

ADSON
46-326
17.5 cm

Ön ve damak için dikiş pensi
Designed for frontal and palate
suture



HEANEY
46-327
20 cm



JAMESON
46-328
23 cm



MASSON
46-329
26.5 cm



WANGENSTEEN
46-330
27.5 cm

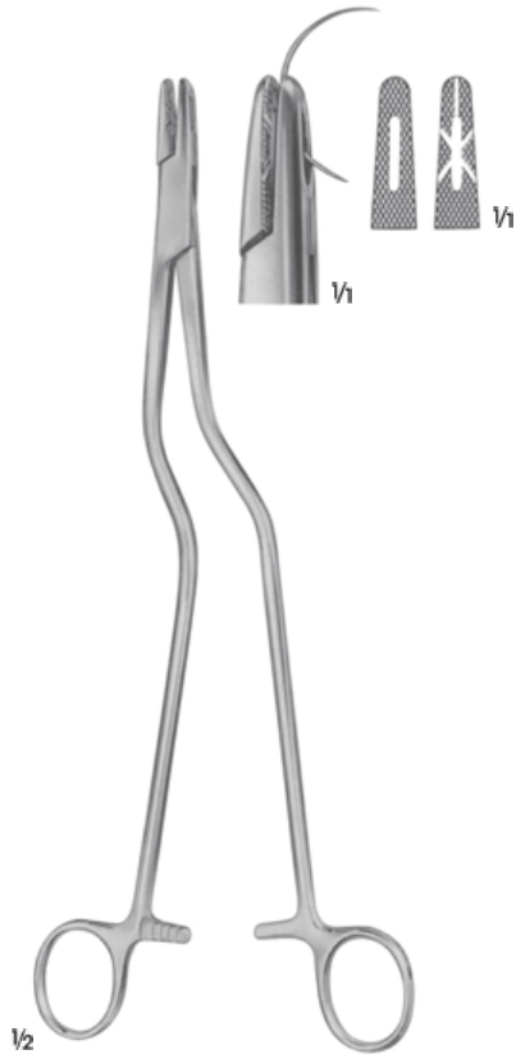

MASSON-LUETHY
46-331
25.5 cm



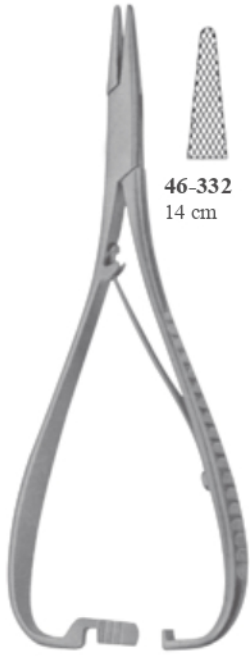

46-332
14 cm



46-333
17 cm



46-334
20 cm

MATHIEU



46-335

46-336



17.5 cm



20 cm

MATHIEU-STILLE
Çok zorlu operasyon için
Very heavy patterns



1/2

CRILE
46-337
15 cm



1/1



1/2

TÖNNIS
46-338
Dura ve bağırsak dikiş pensi
Elastic pattern for dura-or intestinal suture
18 cm



1/1



HEGAR-OLSEN

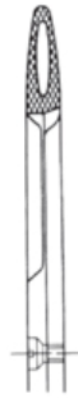

46-339
14 cm



46-340
18.5 cm



GILLIES
46-341
15 cm



GILLIES
46-342
16 cm



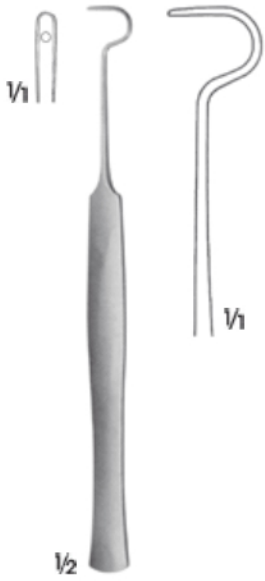

46-343
15 cm



SYME
46-344
17 cm



JONESCO
46-345
Dikiş teli Klavuzu
Needle for wire suture
18.5 cm

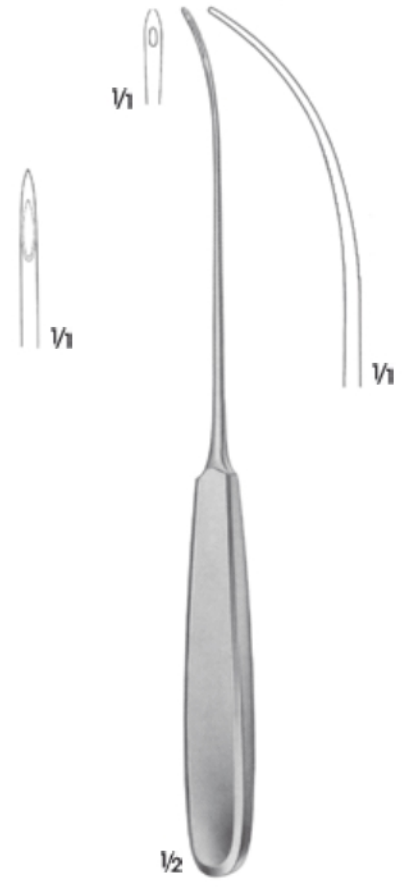

46-346
Bükülebilir/
Malleable 23 cm



CLAUS VAN EICKEN
46-347
25 cm



COOPER
46-348
20.5 cm

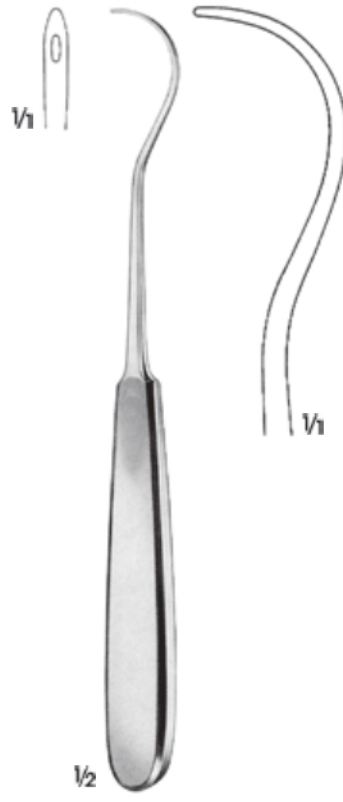

KOCHER
46-349
20.5 cm

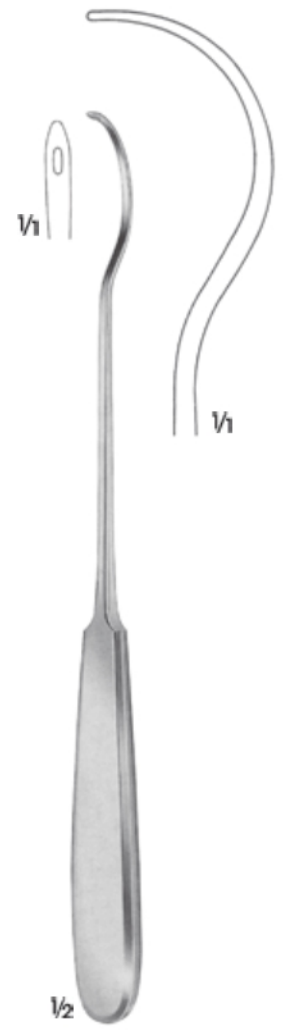

BRUNNER
46-350
24 cm





PAYR
46-351
19.5 cm

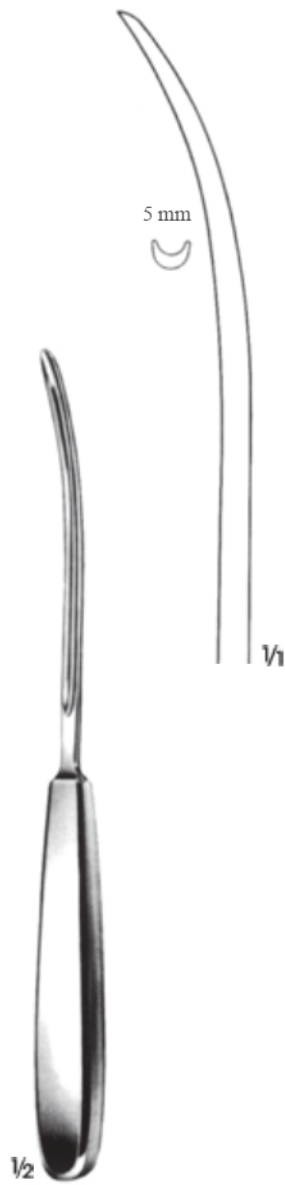

PAYR
46-352
22.5 cm



KOCHER
46-353
15 cm

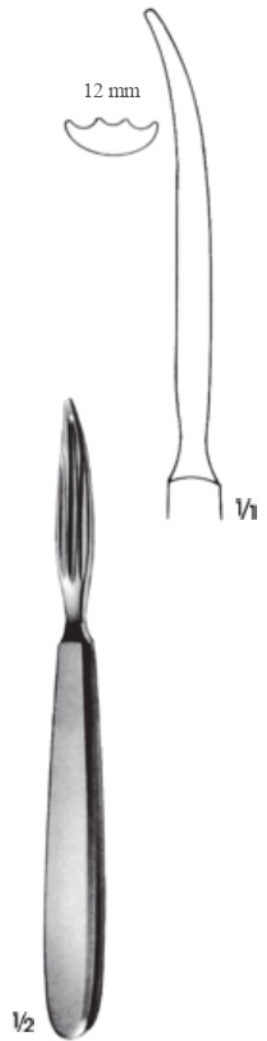

KOCHER
46-354
17 cm

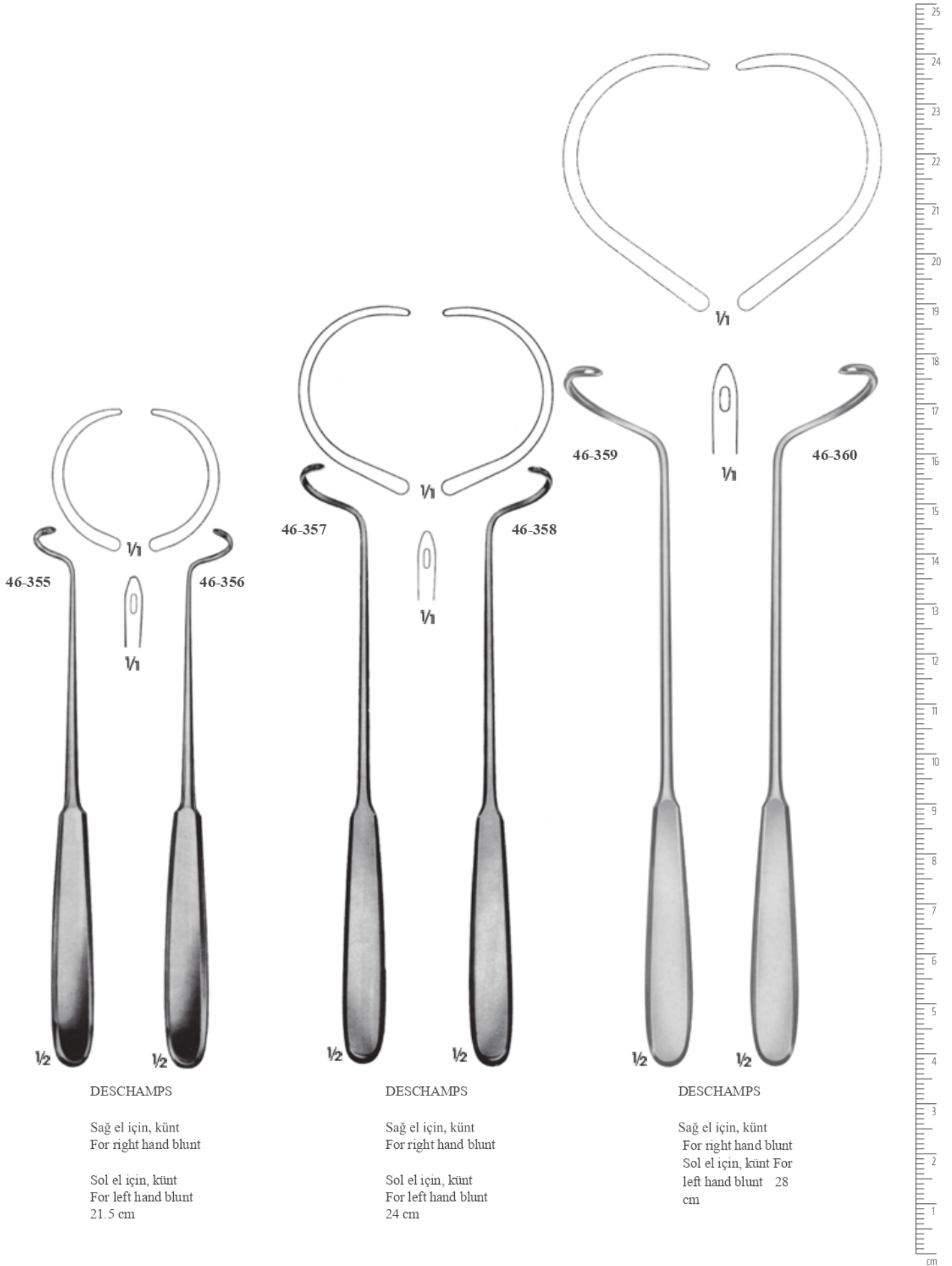

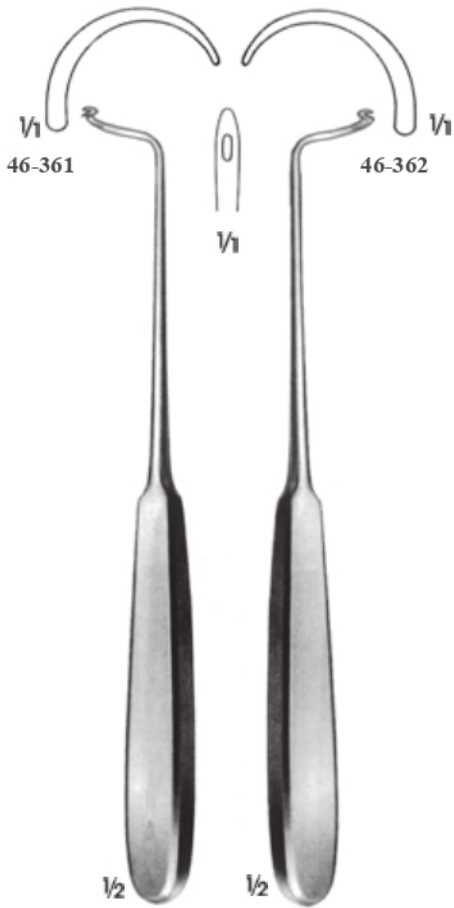

DESCHAMPS

Sağ el için, künt
For right hand blunt

Sol el için, künt
For left hand blunt
21 cm

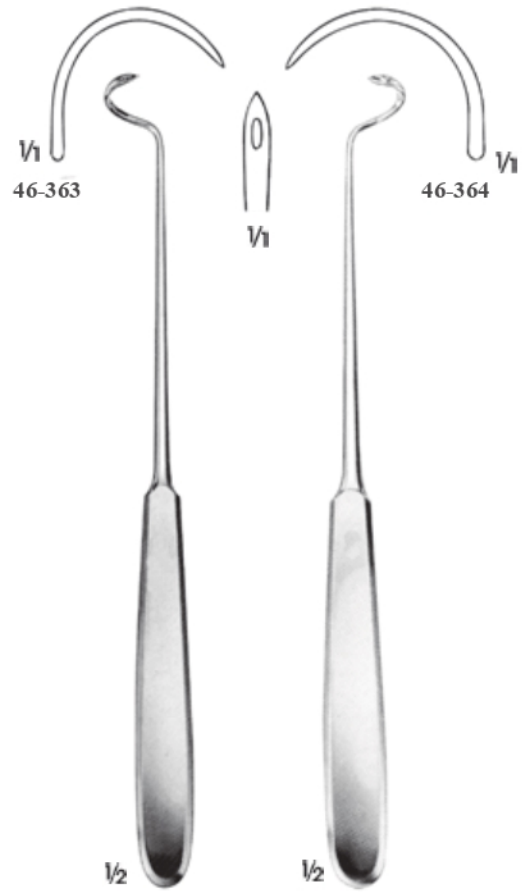

DESCHAMPS

Sağ el için, künt
For right hand blunt

Sol el için, künt
For left hand blunt
21.5 cm

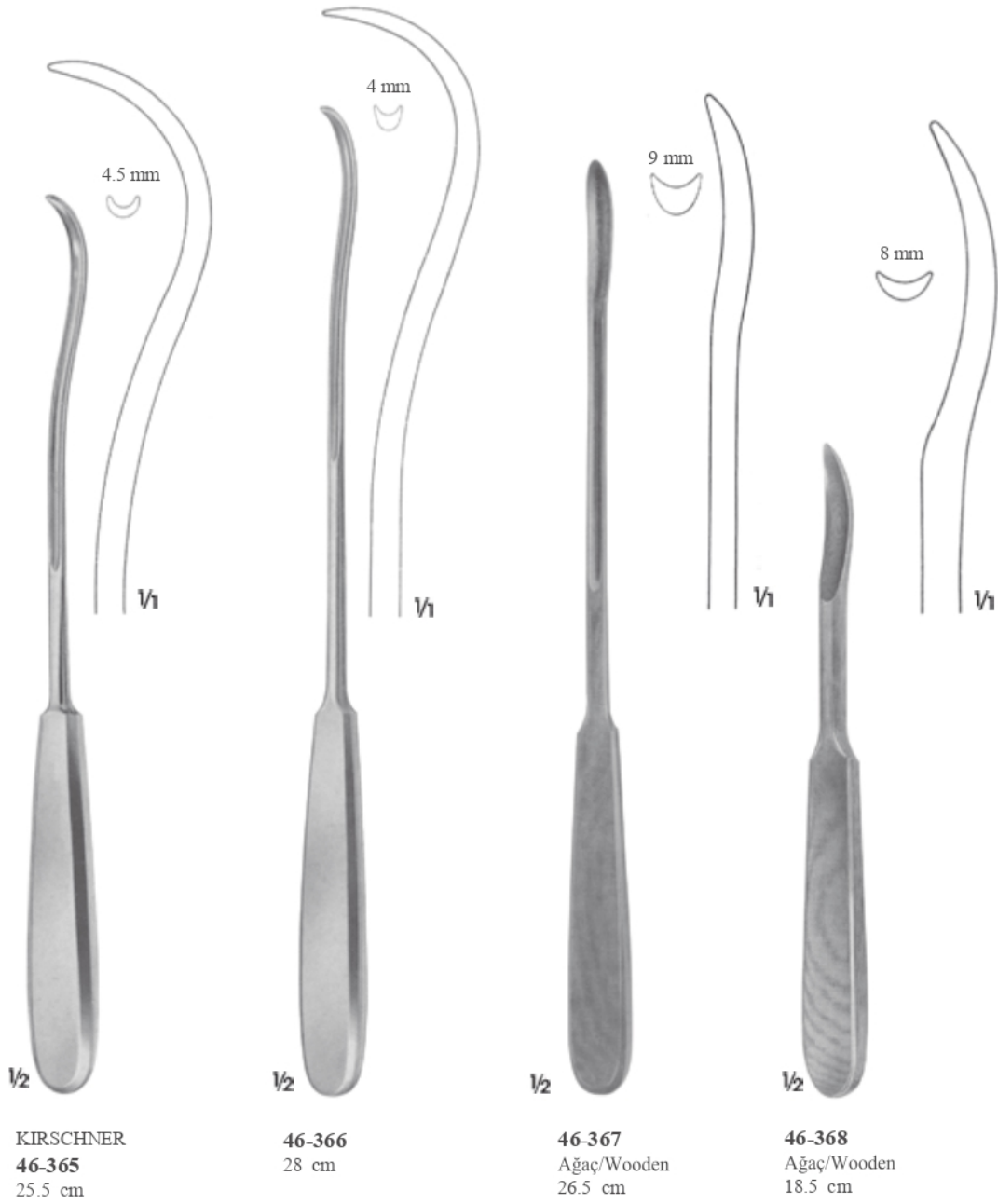



DESCHAMPS

Sağ el için, sivri
For right hand sharp

Sol el için, künt For
left hand sharp 21
cm



HURD

Sağ el için, sivri
For right hand sharp

Sol el için, künt
For left hand sharp
21 cm

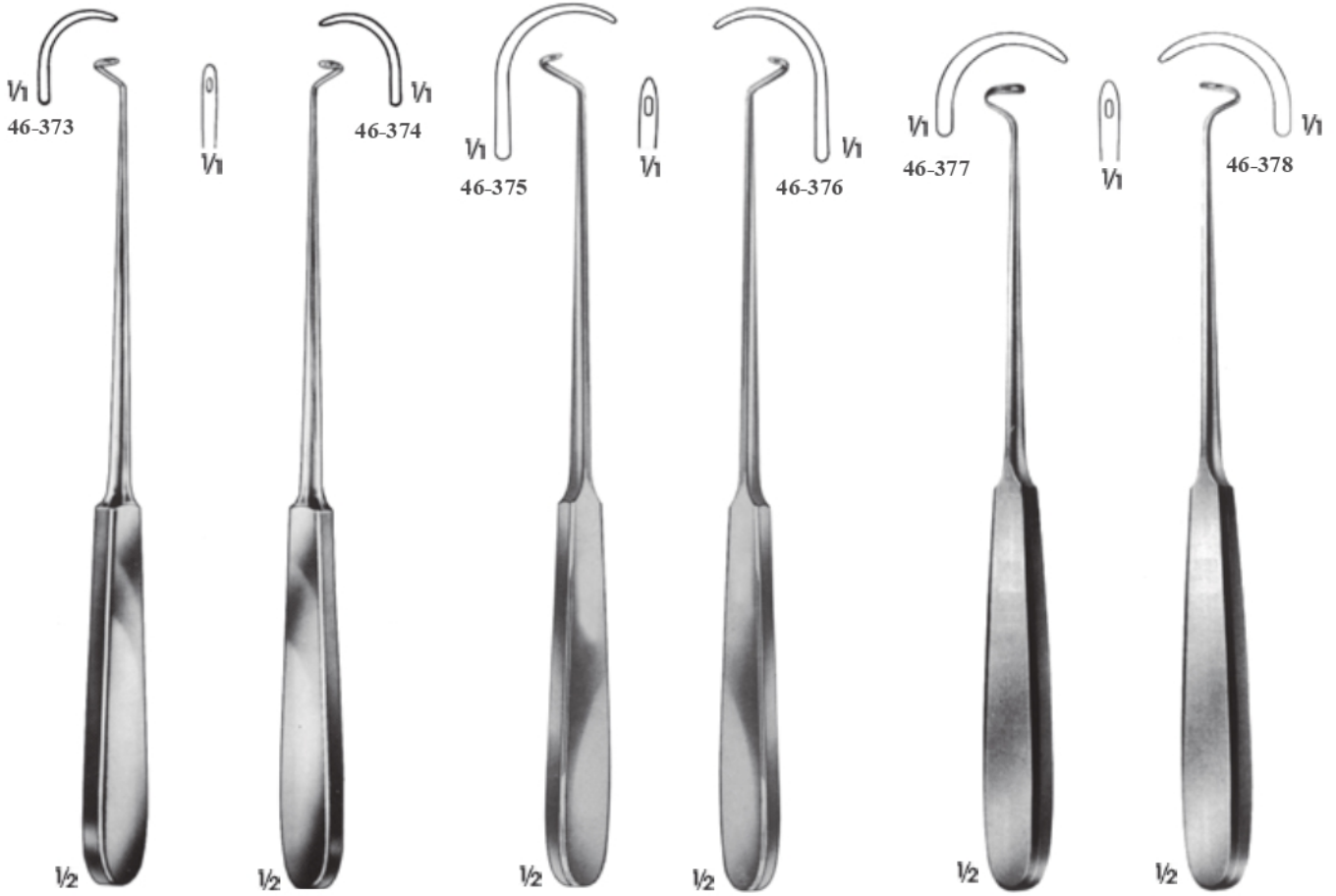

DESCHAMPS

Sağ el için, künt
For right hand blunt

Sol el için, künt
For left hand blunt
22.5 cm

DESCHAMPS

Sağ el için, künt
For right hand blunt

Sol el için, künt
For left hand blunt
22.5 cm

DESCHAMPS

Sağ el için, künt
For right hand blunt

Sol el için, künt
For left hand blunt
21.5 cm

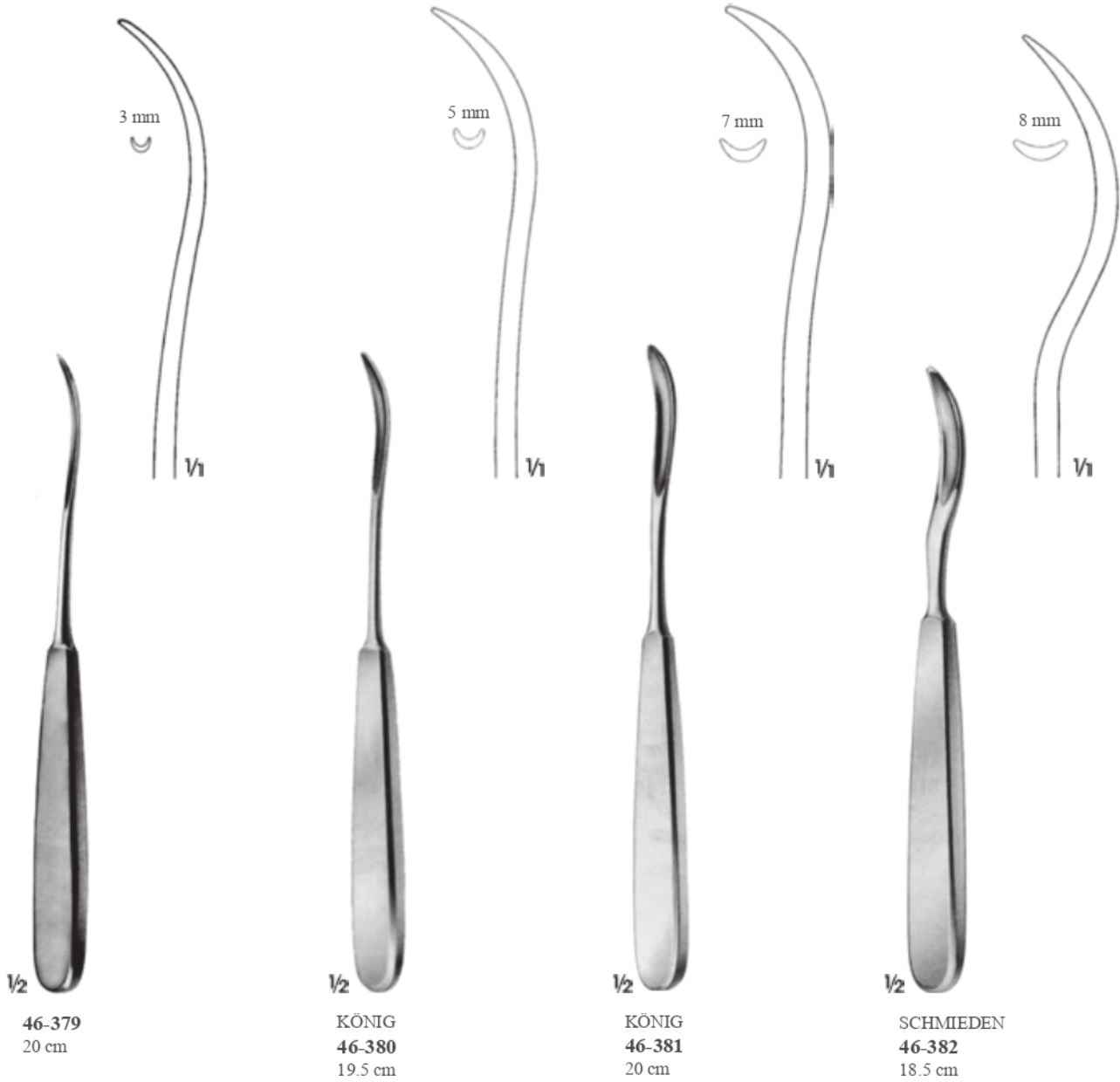



1/2
YOUNG-HRYNTSCHAK
46-383
1 iğne ile T16-306
With 1 needle T16-306 24
cm



1/1
46-384



1/1
46-385



1/1
46-386



1/2
MILLIN
46-387
Ligatur tutucu pens
Ligature holding forceps
28.5 cm



MICHEL
46-388
Klip uygulayıcı ve çıkarıcı pens
Clip applying and removing forcep
12.5 cm



MICHEL
46-389
Klip Uygulayıcı ve çıkarıcı pens
Clip applying and removing forcep
13 cm



COLLIN
46-390
Klip çıkarıcı pens
Clip removing forcep
13.5 cm



HEATH
46-391
Klip çıkarıcı pens
Clip removing forcep
13.5 cm



46-392
Düğüm aparatı
Attachment node
23 cm



1/1



CASPAR
46-393
Düğüm aparatı
Attachment node
23 cm



1/1



MICHEL
46-394
Klip uygulayıcı penset
Clip applying forcep
12.5 cm



HEGENBARTH
46-395
Klip uygulayıcı penset
Clip applying forcep
12 cm





46-396

BRUNNER

Kılavuz sondaları/Guiding probes
30 cm



46-397



46-398

BRUNNER

Bağlama iğneleri/Ligature needles
30 cm



46-399

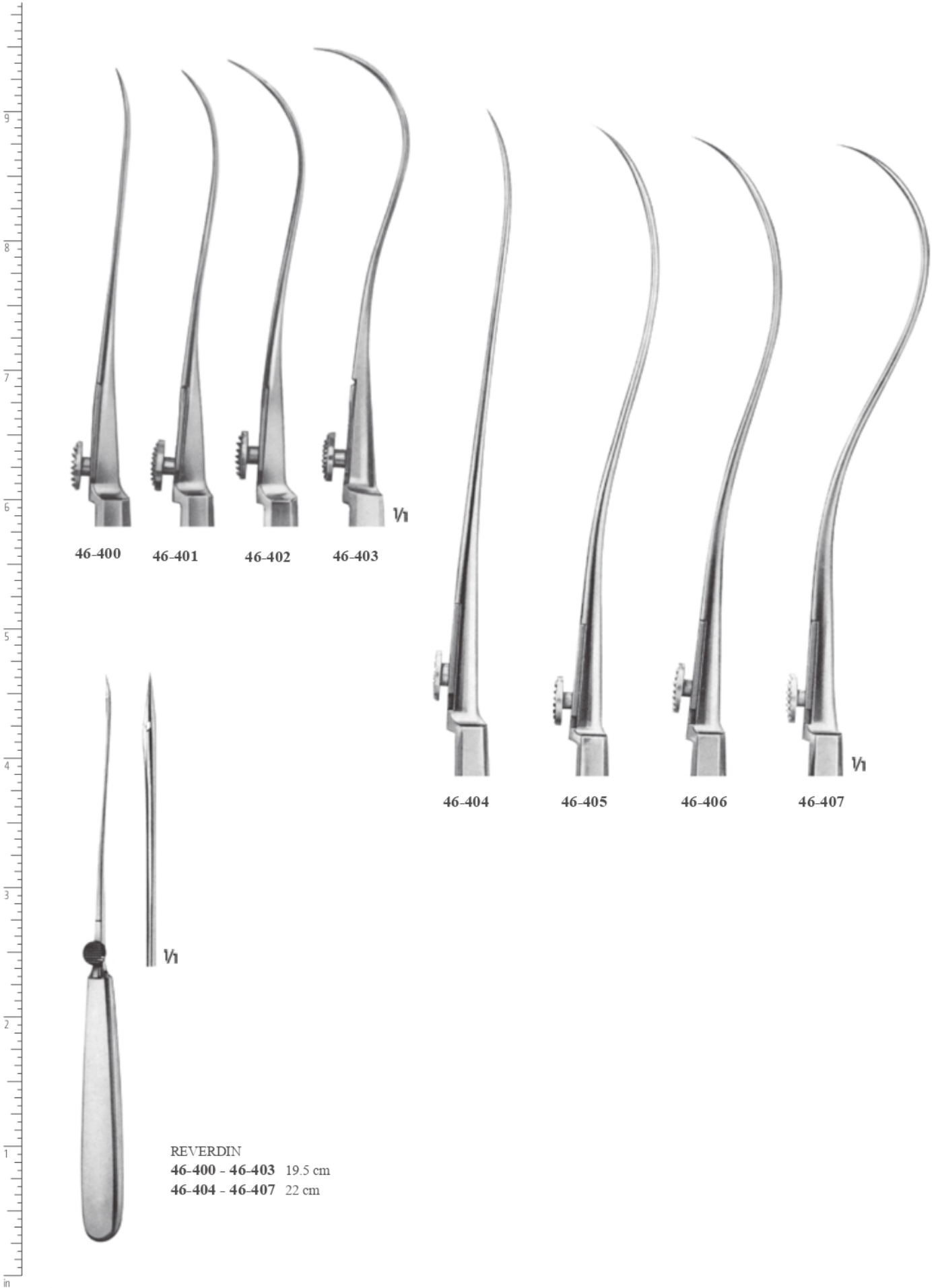



ASCLASS

ASCLASS CERRAHİ ALETLER İMALAT SAN. VE TİC. LTD.ŞTİ

 [asclasscerrahialetler.ve.medya](https://www.instagram.com/asclasscerrahialetler.ve.medya)  [Asclass cerrahi aletler](https://www.facebook.com/Asclass.cerrahi.aletler)  www.asclassgrup.com  info@asclassgrup.com - asclassmedya@gmail.com

 Çatalarmut Mahallesi Sezgin Sokak No:7 Kat:1/2/3 İlkadım/SAMSUN